



Figure can vary

Part no.: 68023103
MLC520R14-300MG
Safety light curtain receiver



Contents

- Technical data
- Suitable transmitters
- Dimensioned drawings
- Electrical connection
- Part number code
- Accessories
- Notes

Technical data

Basic data	
Series	MLC 500
Device type	Receiver
Cascading	Middle Guest
Contains	2x BT-NC sliding block
Application	Finger protection
Characteristic parameters	
Type	4, IEC/EN 61496
SIL	3, IEC 61508
SILCL	3, IEC/EN 62061
Performance Level (PL)	e, EN ISO 13849-1
Mission time T_M	20 years, EN ISO 13849-1
Category	4, EN ISO 13849
Protective field data	
Resolution	14 mm
Protective field height	300 mm
Optical data	
Number of beams	30 Piece(s)
Timing	
Response time	7 ms
Connection	
Number of connections	2 Piece(s)
Connection 1	
Type of connection	Cable with connector
Function	Cascade, Host In
Cable length	330 mm
Sheathing material	PUR
Thread size	M12
Material	Plastic
No. of pins	8 -pin
Connection 2	
Type of connection	Cable with connector
Function	Cascade, Guest Out
Cable length	330 mm
Sheathing material	PUR
Thread size	M12
Material	Plastic
No. of pins	8 -pin
Mechanical data	
Dimension (W x H x L)	29 mm x 314 mm x 53 mm
Housing material	Metal, Aluminum

Part no.: 68023103 – MLC520R14-300MG – Safety light curtain receiver

Lens cover material	Plastic / PMMA
Material of end caps	Diecast zinc
Net weight	498 g
Housing color	Yellow, RAL 1021
Type of fastening	Mounting bracket Swivel mount Groove mounting

Environmental data

Ambient temperature, operation	0 ... 55 °C
Ambient temperature, storage	-30 ... 70 °C
Relative humidity (non-condensing)	0 ... 95 %

Certifications

Degree of protection	IP 65
Protection class	III
Certifications	TÜV Süd c CSA US c TÜV NRTL US
Vibration resistance	50 m/s ²
Shock resistance	100 m/s ²
US patents	US 6,418,546 B

Classification

eCl@ss 8.0	27272704
eCl@ss 9.0	27272704
ETIM 5.0	EC002549

Suitable transmitters

	Part no.	Designation	Article	Description
	68022103	MLC500T14-300MG	Safety light curtain transmitter	Resolution: 14 mm Protective field height: 300 mm Operating range: 0 ... 6 m Connection: Cable with connector, M12, Plastic, 8 -pin, 330 mm, PUR

Dimensioned drawings

All dimensions in millimeters

Calculation of the effective protective field height $H_{PFE} = H_{PFN} + B + C$

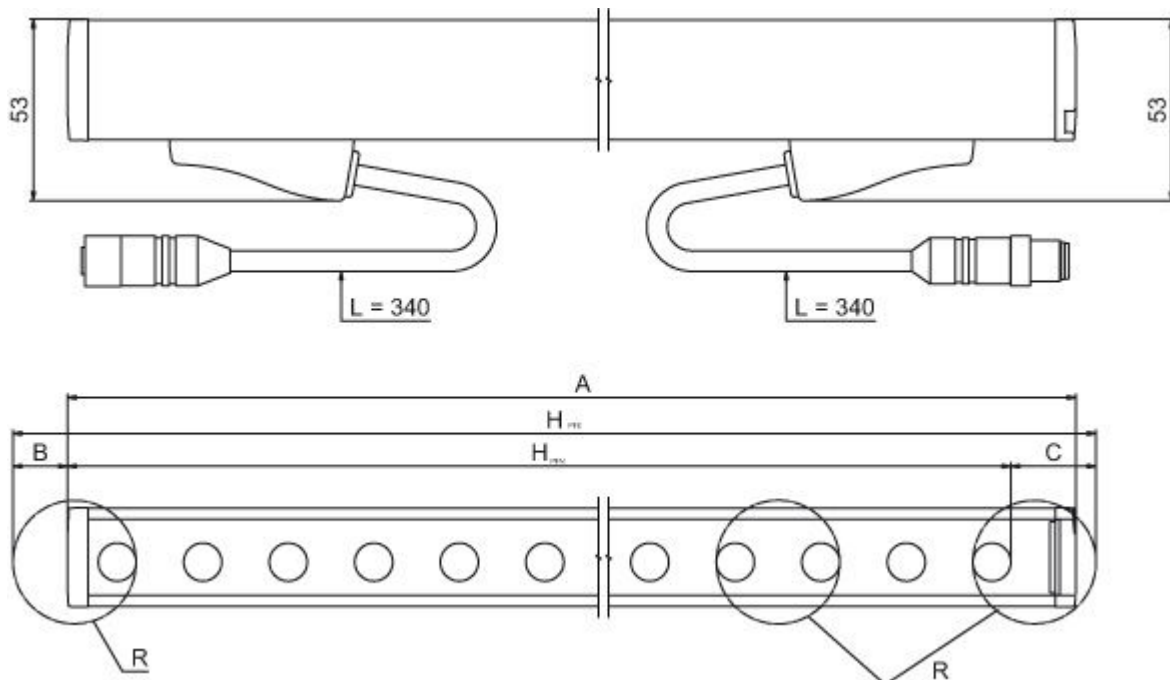

- HPFE Effective protective field height = 312 mm
- HPFN Nominal protective field height = 300 mm
- A Total height = 314 mm
- B 6 mm
- C 6 mm
- R Effective protective field height H_{PFE} goes beyond the dimensions of the optics area to the outer borders of the circles labeled with R.

Electrical connection

Connection 1	
Type of connection	Cable with connector
Function	Cascade, Host In
Cable length	330 mm
Sheathing material	PUR
Cable color	Black
Type of stranding	Pair stranding (twisted pair)
Wire cross section	0.14 mm ²
Thread size	M12
Type	Male
Material	Plastic
No. of pins	8 -pin
Encoding	A-coded

Connection 2	
Type of connection	Cable with connector
Function	Cascade, Guest Out
Cable length	330 mm
Sheathing material	PUR

Part no.: 68023103 – MLC520R14-300MG – Safety light curtain receiver

Connection 2	
Cable color	Black
Wire cross section	0.14 mm ²
Type of stranding	Pair stranding (twisted pair)
Thread size	M12
Type	Female
Material	Plastic
No. of pins	8 -pin
Encoding	A-coded

Part number code

Part designation: **MLCxyy-za-hhhhei-ooo**

MLC	Safety light curtain
x	Series: 3: MLC 300 5: MLC 500
yy	Function classes: 00: Transmitter 01: transmitter (AIDA) 02: Transmitter with test input 10: Basic receiver - automatic restart 11: basic receiver - automatic restart (AIDA) 20: Standard receiver - EDM/RES selectable 30: Extended receiver - blanking/muting
z	Device type: T: transmitter R: receiver
a	Resolution: 14: 14 mm 20: 20 mm 30: 30 mm 40: 40 mm 90: 90 mm
hhh	Protective field height: 150 ... 3000: from 150 mm to 3000 mm
e	Host/Guest (optional): H: Host MG: Middle Guest G: Guest
i	Interface (optional): /A: AS-i
ooo	Option: /V: high Vibration-proof EX2: explosion protection (zones 2 + 22) SPG: Smart Process Gating

Note

A list with all available device types can be found on the Leuze electronic website at www.leuze.com.

Accessories

Mounting technology - Mounting brackets

	Part no.	Designation	Article	Description
	429056	BT-2L	Mounting bracket set	Design of mounting device: Angle, L-shape Mounting bracket, at system: Through-hole mounting Mounting bracket, at device: Screw type Material: Metal
	429006	BT-2L-HG	Mounting device set	Mounting bracket, at device: Screw type Material: Metal
	429057	BT-2Z	Mounting bracket set	Design of mounting device: Angle, Z-shape Mounting bracket, at system: Through-hole mounting Mounting bracket, at device: Screw type Material: Metal
	429005	BT-L-HG	Mounting device set	Mounting bracket, at device: Screw type Material: Metal





Mounting technology - Swivel mounts

	Part no.	Designation	Article	Description
	429395	BT-2HF-G	Mounting bracket set	Contains: 2x BT-HF swivel mount, 2 cylinders for mounting on the light curtain Mounting bracket, at system: Through-hole mounting Mounting bracket, at device: Clampable Type of mounting device: Turning, 360° Material: Metal, Plastic
	429396	BT-2HF-GS	Mounting bracket set	Contains: 2x BT-HF swivel mount, 2 cylinders for mounting on the light curtain Mounting bracket, at system: Through-hole mounting Mounting bracket, at device: Clampable Type of mounting device: Turning, 360° Material: Metal, Plastic Shock absorber: Yes
	429029	BT-2RG	Mounting bracket set	Contains: 2x BT-R swivel mount, 2 cylinders for mounting on the light curtain Mounting bracket, at system: Through-hole mounting Mounting bracket, at device: Clampable Type of mounting device: Turning, 360° Material: Metal, Plastic



Mounting technology - Other

	Part no.	Designation	Article	Description
	425740	BT-10NC60	Sliding block set	Contains: 10x BT-NC sliding block Bore hole 1: Ø 4.7 mm Bore hole 2: M6 Design of mounting device: Sliding block Mounting bracket, at system: Mounting thread Mounting bracket, at device: Groove mounting Material: Metal



Part no.: 68023103 – MLC520R14-300MG – Safety light curtain receiver

	Part no.	Designation	Article	Description
	425741	BT-10NC64	Sliding block set	Contains: 10x BT-NC-M4-M6 sliding block Bore hole 1: M4 Bore hole 2: M6 Design of mounting device: Sliding block Mounting bracket, at system: Mounting thread Mounting bracket, at device: Groove mounting Material: Metal
	425742	BT-10NC65	Sliding block set	Contains: 10x BT-NC-M5-M6 sliding block Bore hole 1: M5 Bore hole 2: M6 Design of mounting device: Sliding block Mounting bracket, at system: Mounting thread Mounting bracket, at device: Groove mounting Material: Metal
	424422	BT-2SB10	Mounting bracket set	Contains: 2x BT-SB10 Design of mounting device: Mounting clamp Mounting bracket, at system: Through-hole mounting Mounting bracket, at device: Clampable, an der seitlichen C-Nut Type of mounting device: Swiveling Swivel range: -8 ... 8 ° Material: Metal
	424423	BT-2SB10-S	Mounting bracket set	Contains: 2x BT-SB10-S Design of mounting device: Mounting clamp Mounting bracket, at system: Through-hole mounting Mounting bracket, at device: Clampable, an der seitlichen C-Nut Swivel range: -8 ... 8 ° Material: Metal Shock absorber: Yes

Alignment aids

	Part no.	Designation	Article	Description
	427300	AC-ALM	Alignment aid	Housing material: Plastic
	520101	AC-ALM-M	Alignment aid	Housing material: Plastic
	560020	LA-78U	Alignment aid	Light source: laser, Red Housing material: Metal

Protective screens

	Part no.	Designation	Article	Description
	429038	MLC-2PSF	Mounting bracket set	Type of fastening: Clampable Mounting device material: Metal
	347072	MLC-PS300	Protective screen	Protective field height: 300 mm Material: PMMA, clear

Notes

Observe intended use!

- The product may only be put into operation by competent persons.
- Only use the product in accordance with its intended use.